



**WIFI-Link™ Technologies Inc.**

歲海尼可網路科技有限公司

WEB: <http://www.wifi-link.com.tw/> TEL: 06-2523801 FAX: 06-2526033

**14dBi 指向天線防水盒(2.4GHz E-Tenna IV™)**

**WL-ETIV-2450-14**

## **APPLICATIONS AND FEATURES**

### **Applications:**

- 2.4~2.5 GHz Applications
- IEEE 802.11b/g/n MIMO Wireless LAN
- Public Wireless Hotspot
- Directional application
- Wi-Fi, RFID
- Wireless Video Systems
- Bluetooth

### **Features :**

- Superior Performance
- Made with weatherproof and corrosion resistant
- Good appearance design
- Installed for vertical or horizontal polarization
- Heavy Duty mounting
- RoHS Compliant
- Waterproof grade ip66



## **SPECIFICATIONS:**

### **Electrical Specifications**

Frequency Range	2400~2500MHz
V.S.W.R	≤ 1.5:1
Return Loss	≥ -14db
Antenna Type	PCB patch
Gain	14dBi
Polarization	Vertical or Horizontal
Maximum Power	50W
Vertical Beam-with	42°
Horizontal Beam-with	42°
Impedance	50Ω
Connector	SMA Female x2

### **Mechanical Specifications**

Size	253 x 253 x 70mm
Weight	1300g
Wind Survival	> 150 MPH
Radome Material	ABS+UV resistance
Clamps	U-bolt
Mounting	92mm
Operating Temperature	-40°C to +80°C

# Antenna Horizontal Pattern

Vertical

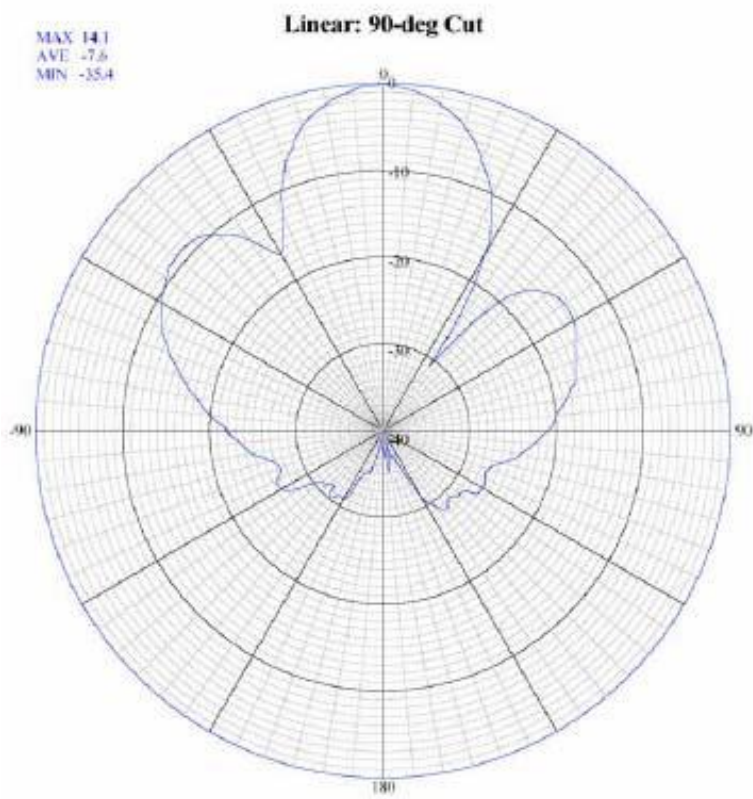

Horizontal

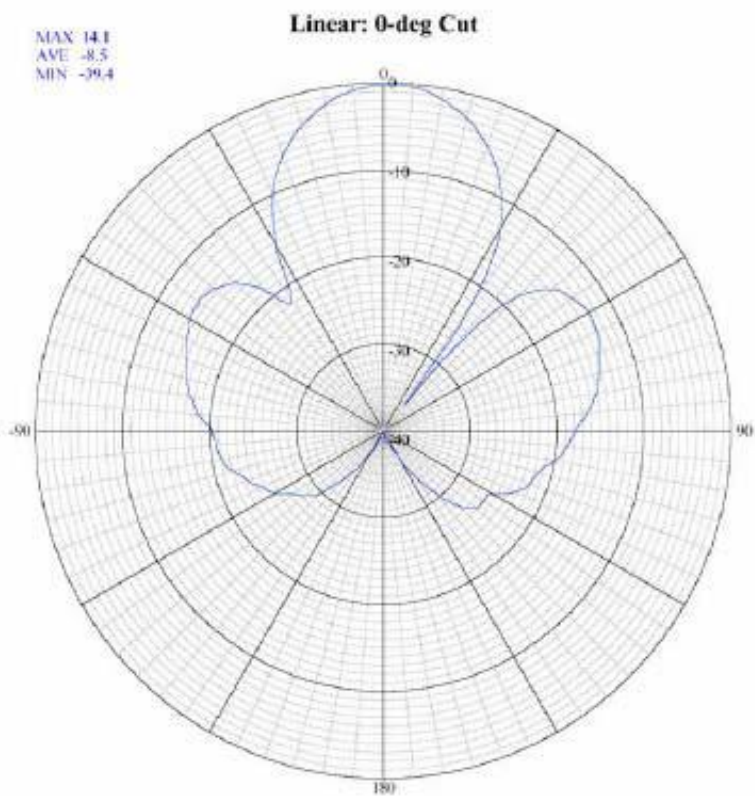

# TESTING REPORT Port 1

## Return Loss

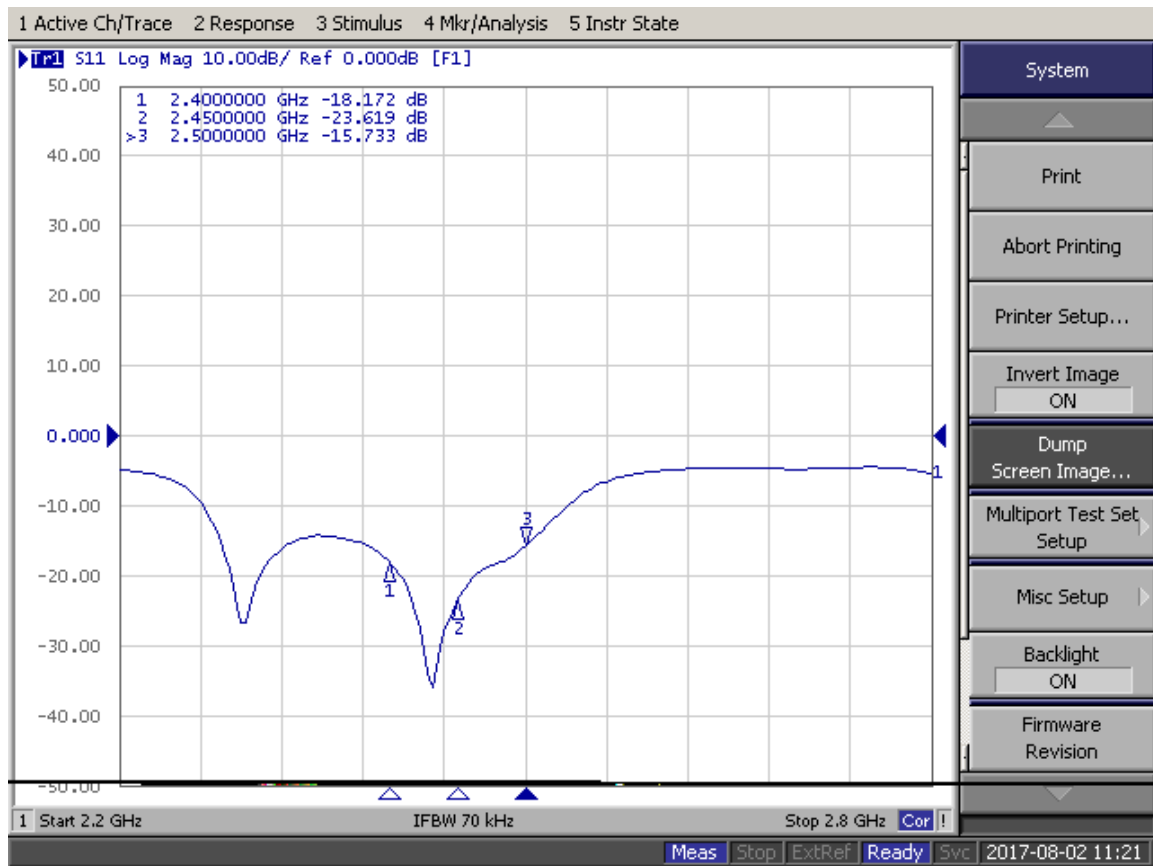

## V.S.W.R

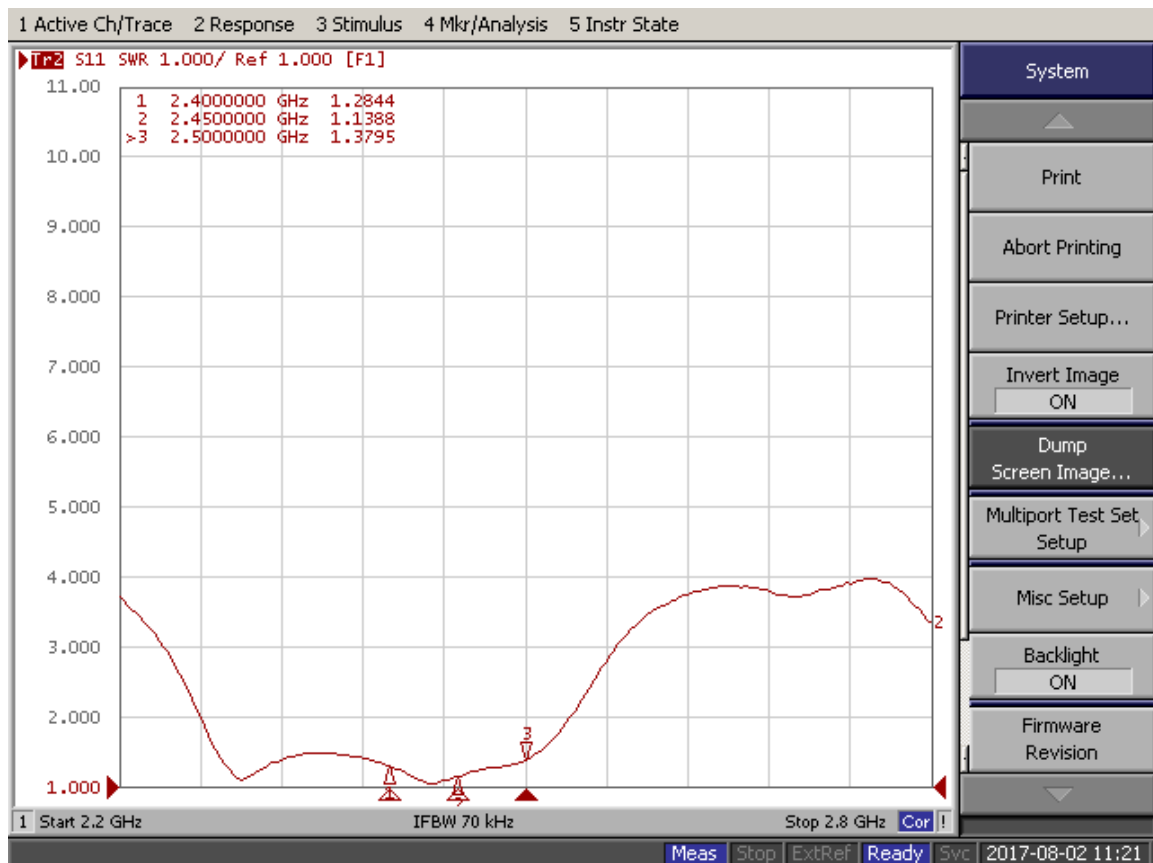

# TESTING REPORT Port 2

## Return Loss

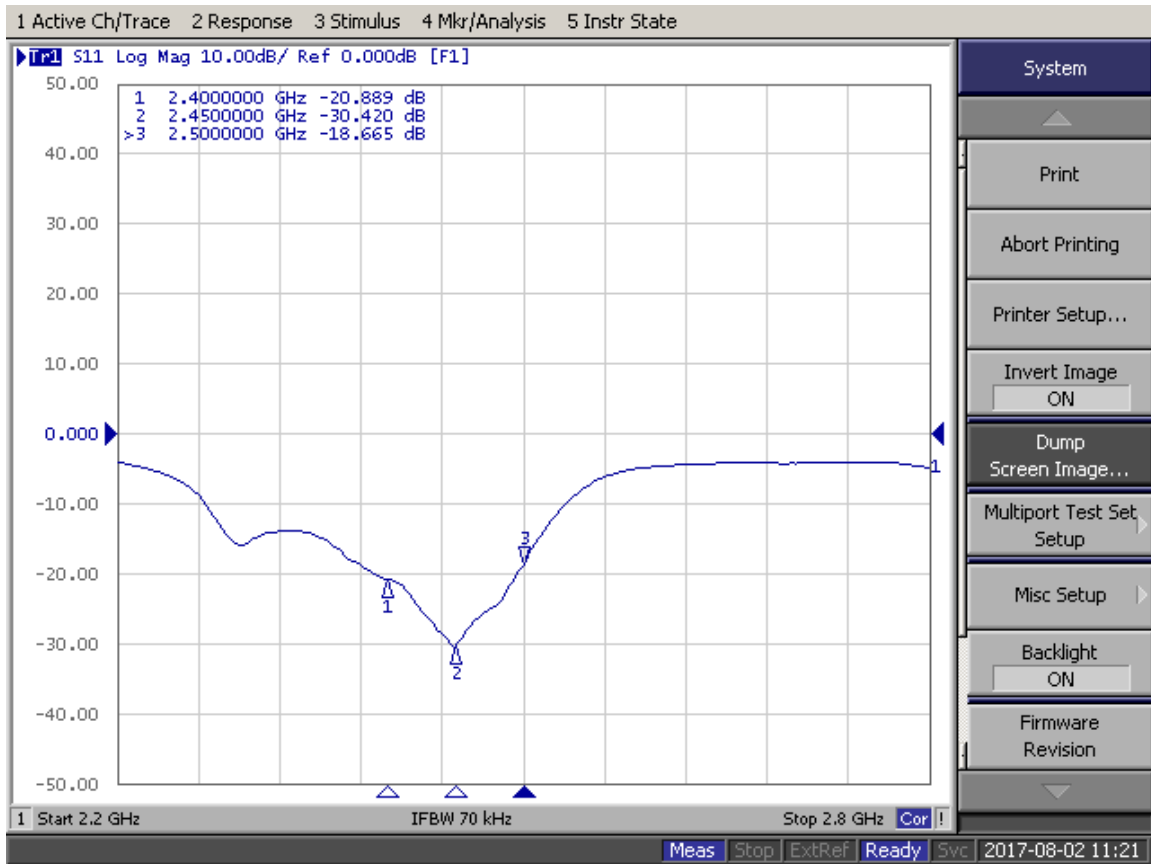

## V.S.W.R

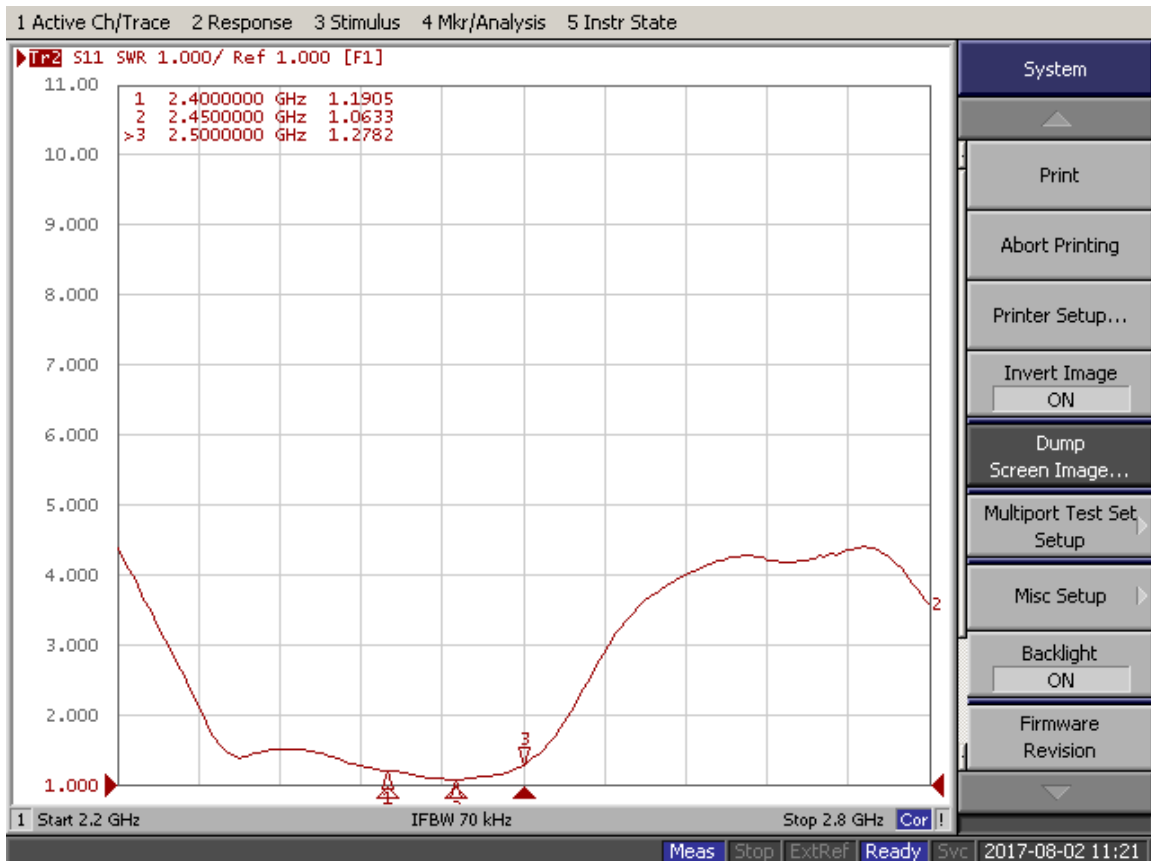

# WL-ETIV-2450-14

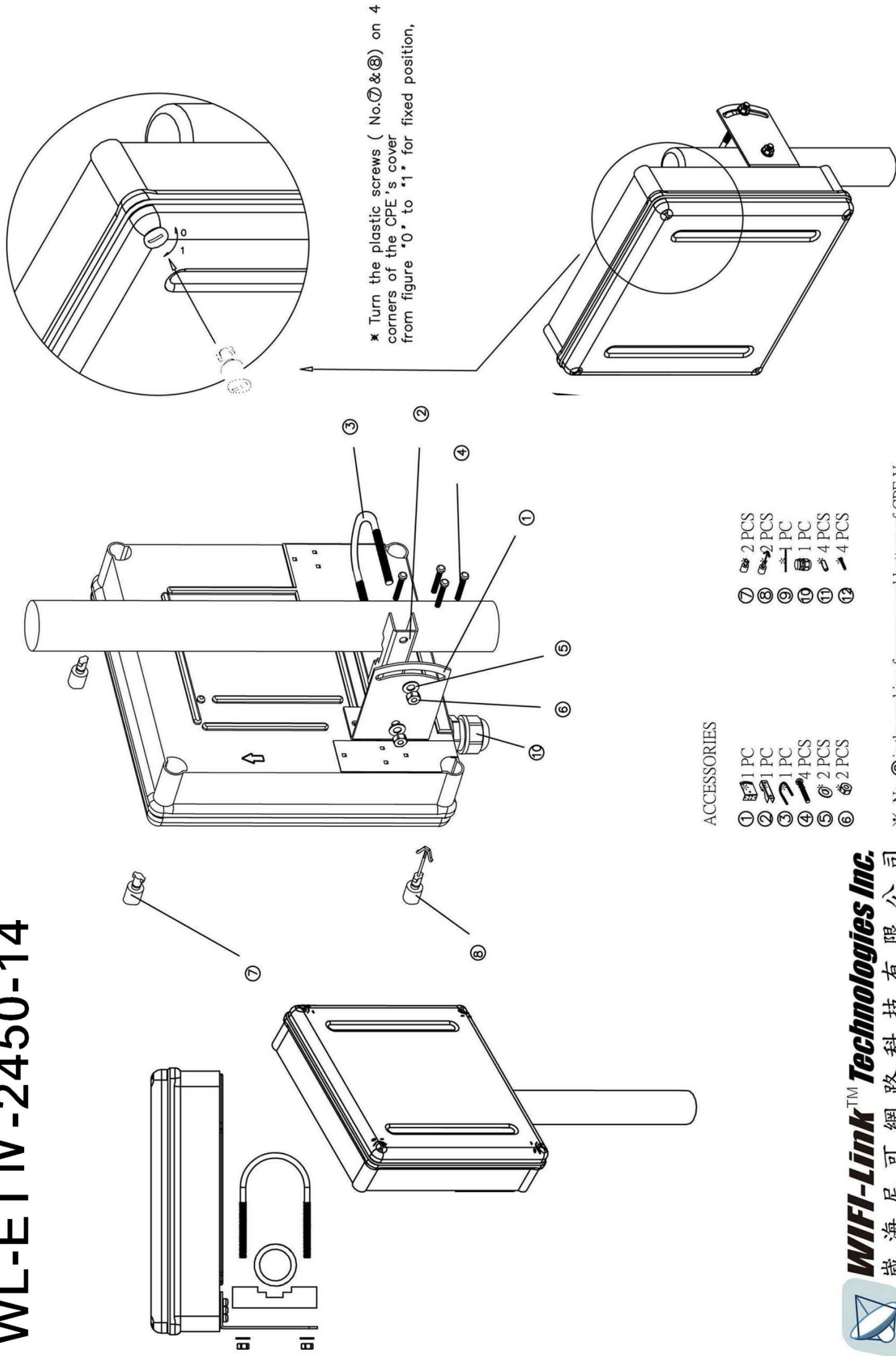

\* Turn the plastic screws ( No.⑦&⑧) on 4 corners of the CPE's cover from figure "0" to "1" for fixed position,

### ACCESSORIES

- ① 1 PC
- ② 1 PC
- ③ 1 PC
- ④ 4 PCS
- ⑤ 2 PCS
- ⑥ 2 PCS
- ⑦ 2 PCS
- ⑧ 2 PCS
- ⑨ 1 PC
- ⑩ 1 PC
- ⑪ 4 PCS
- ⑫ 4 PCS

\* No. ⑨ is the packing for cover and bottom of CPE V  
 No. ⑪ & ⑫ are the accessories for Router/AP.